

DSI Columns®

MADE
IN THE
USA 

ALUMINUM

BEAUTIFUL. DURABLE. STRUCTURAL.



ROUND FLUTED



Round Fluted Columns are complimented by matching capitals and bases. These structural columns are available in 6", 8", 10" and 12" diameter.

DSI is the only aluminum column supplier to receive PCI 4000 A2 & A3 certification from the Powder Coating Institute. All columns are verified AAMA 2604 compliant. An optional AAMA 2605 upgrade is available by special order.

ROUND FLUTED

Nominal Size	Shipping Weight (lbs.)	Dimensions			
		A Outside	A Inside	B	C
6" x 8' * •	19	6"	5-3/8"	7-9/16"	1-3/4"
6" x 9' * •	21	6"	5-3/8"	7-9/16"	1-3/4"
6" x 10' * •	23	6"	5-3/8"	7-9/16"	1-3/4"
8" x 8' * •	24	7-5/8"	7"	9-7/16"	2-1/8"
8" x 9' * •	27	7-5/8"	7"	9-7/16"	2-1/8"
8" x 10' * •	30	7-5/8"	7"	9-7/16"	2-1/8"
8" x 12' §	32	7-5/8"	7"	9-7/16"	2-1/8"
10" x 8'	33	9-3/8"	8-3/4"	11-1/4"	2-3/8"
10" x 9'	36	9-3/8"	8-3/4"	11-1/4"	2-3/8"
10" x 10'	38	9-3/8"	8-3/4"	11-1/4"	2-3/8"
10" x 12' §	47	9-3/8"	8-3/4"	11-1/4"	2-3/8"
10" x 20' §	75	9-3/8"	8-3/4"	11-1/4"	2-3/8"
12" x 10' §	65	11-1/2"	11"	15-1/8"	2-15/16"
12" x 16' §	99	11-1/2"	11"	15-1/8"	2-15/16"
12" x 20' §	115	11-1/2"	11"	15-1/8"	2-15/16"

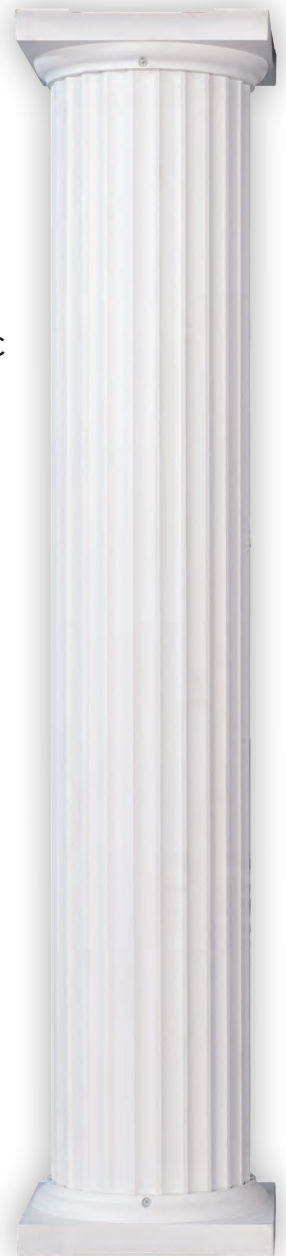
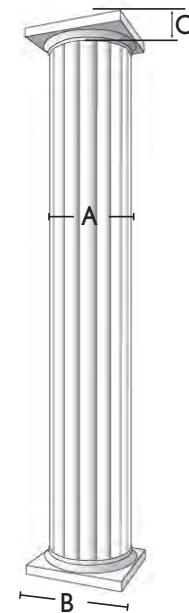

* Quick Ship Program (Gloss White)

• Column boxes include: 1 pc capital, 1 pc base, and 8 angle brackets

§ Special Order: May require longer lead times.

NOTE: Capitals and Bases are not included with columns unless indicated. Angle Brackets (8 pack) or Tie Down Brackets (2 sets) must be ordered separately from columns unless indicated.



Capital
(Low Profile)



Base
(Low Profile)

FEATURES



- **Certified PCI 4000 A2 (AAMA 2604) & A3 (AAMA 2605)**
- **Verified AAMA 2604/2605 Compliant**
- Available in 12 colors
- Matching aluminum capitals and bases

- Load bearing†
(Visit dsicolumns.com for more information)
- Ideal for commercial and residential applications
- Can wrap around existing post
(modifications may be necessary)
- Lifetime Limited Warranty

† Load-bearing capacity is dependent on distributing the load evenly over bearing surfaces of the shaft. All installation information is of general nature; columns should be installed and secured (fastened) according to standard construction practices and in compliance with applicable local, state and federal building regulations.
Note: 2nd story balconies should not be attached directly to the side of any column.

SQUARE FLUTED



Our Traditional Square Fluted Columns come in 6", 8", 10" and 12" square. These structural columns are complimented with capitals and bases offering both peace of mind and a beautiful finished look.

DSI is the only aluminum column supplier to receive PCI 4000 A2 & A3 certification from the Powder Coating Institute. All columns are verified AAMA 2604 compliant. An optional AAMA 2605 upgrade is available by special order.

SQUARE FLUTED

Nominal Size	Shipping Weight (lbs.)	Dimensions			
		A Outside	A Inside	B	C
6" x 8' * •	24	5-1/2"	4-1/2"	8-1/2"	2"
6" x 9' * •	27	5-1/2"	4-1/2"	8-1/2"	2"
6" x 10' * •	30	5-1/2"	4-1/2"	8-1/2"	2"
8" x 8' * •	26	7-1/2"	6-1/2"	10-1/2"	2"
8" x 9' * •	29	7-1/2"	6-1/2"	10-1/2"	2"
8" x 10' * •	32	7-1/2"	6-1/2"	10-1/2"	2"
8" x 12' §	38	7-1/2"	6-1/2"	10-1/2"	2"
10" x 8'	41	9-1/2"	8-1/2"	12-9/16"	2-11/16"
10" x 9'	46	9-1/2"	8-1/2"	12-9/16"	2-11/16"
10" x 10'	50	9-1/2"	8-1/2"	12-9/16"	2-11/16"
10" x 12' §	59	9-1/2"	8-1/2"	12-9/16"	2-11/16"
10" x 20' §	98	9-1/2"	8-1/2"	12-9/16"	2-11/16"
12" x 10' §	60	11-1/2"	10-1/2"	15-7/16"	3-3/16"
12" x 16' §	92	11-1/2"	10-1/2"	15-7/16"	3-3/16"
12" x 20' §	115	11-1/2"	10-1/2"	15-7/16"	3-3/16"

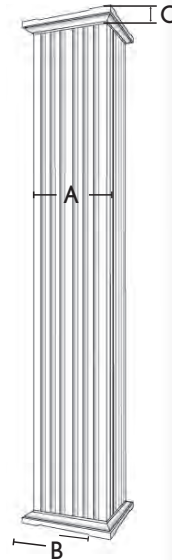

*** Quick Ship Program (Gloss White)**

• Column boxes include: 1 pc capital, 1 pc base, and 8 angle brackets

§ Special Order: May require longer lead times.

NOTE: Capitals and Bases are not included with columns unless indicated. Angle Brackets (8 pack) or Tie Down Brackets (2 sets) must be ordered separately from columns unless indicated.



*Capital
(Low Profile)*



*Base
(Low Profile)*

FEATURES



• **Certified PCI 4000 A2 (AAMA 2604) & A3 (AAMA 2605)**

• **Verified AAMA 2604/2605 Compliant**

• Available in 12 colors

• Matching aluminum capitals and bases

• Load bearing†

(Visit dsicolumns.com for more information)

• Ideal for commercial and residential applications

• Can wrap around existing post (modifications may be necessary)

• Lifetime Limited Warranty

† Load-bearing capacity is dependent on distributing the load evenly over bearing surfaces of the shaft. All installation information is of general nature; columns should be installed and secured (fastened) according to standard construction practices and in compliance with applicable local, state and federal building regulations.

Note: 2nd story balconies should not be attached directly to the side of any column.

SMOOTH WITH ASTRAGAL



Our architecturally pleasing Smooth Columns offer an Astragal with decorative capital and low profile base. These structural columns are offered in 6", 8" and 10" widths.

DSI is the only aluminum column supplier to receive PCI 4000 A2 & A3 certification from the Powder Coating Institute. All columns are verified AAMA 2604 compliant. An optional AAMA 2605 upgrade is available by special order.

Nominal Size	Shipping Weight (lbs.)	Dimensions					
		A Outside	A Inside	B	C	D	E
6" x 8'	25	5-1/2"	4-1/2"	8-1/2"	2-5/8"	2"	9-13/16"
6" x 9'	28	5-1/2"	4-1/2"	8-1/2"	2-5/8"	2"	9-13/16"
6" x 10'	31	5-1/2"	4-1/2"	8-1/2"	2-5/8"	2"	9-13/16"
8" x 8'	27	7-1/2"	6-1/2"	10-1/2"	2-5/8"	2"	11-13/16"
8" x 9'	30	7-1/2"	6-1/2"	10-1/2"	2-5/8"	2"	11-13/16"
8" x 10'	33	7-1/2"	6-1/2"	10-1/2"	2-5/8"	2"	11-13/16"
8" x 12' §	37	7-1/2"	6-1/2"	10-1/2"	2-5/8"	2"	11-13/16"
10" x 8'	42	9-1/2"	8-1/2"	12-9/16"	2-5/8"	2-11/16"	13-13/16"
10" x 9'	49	9-1/2"	8-1/2"	12-9/16"	2-5/8"	2-11/16"	13-13/16"
10" x 10'	53	9-1/2"	8-1/2"	12-9/16"	2-5/8"	2-11/16"	13-13/16"
10" x 12' §	62	9-1/2"	8-1/2"	12-9/16"	2-5/8"	2-11/16"	13-13/16"
10" x 20' §	106	9-1/2"	8-1/2"	12-9/16"	2-5/8"	2-11/16"	13-13/16"

SMOOTH
WITH ASTRAGAL



§ **Special Order: May require longer lead times.**

NOTE: Capitals and Bases are not included with columns unless indicated. Angle Brackets (8 pack) or Tie Down Brackets (2 sets) must be ordered separately from columns unless indicated.



Decorative Capital

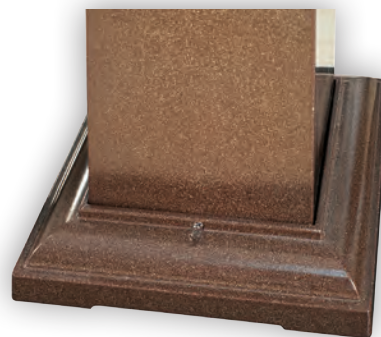

Base
(Low Profile)

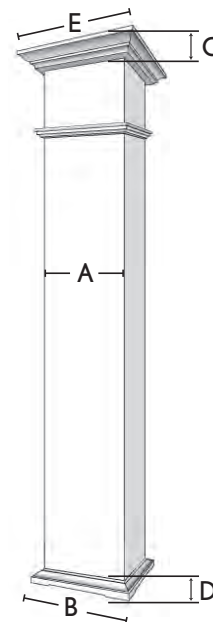

FEATURES



• **Certified PCI 4000 A2 (AAMA 2604) & A3 (AAMA 2605)**



• **Verified AAMA 2604/2605 Compliant**

• Available in 12 colors

• Decorative aluminum capital and low profile base with adjustable height astragal.

- Load bearing† (Visit dsicolumns.com for more information)
- Ideal for commercial and residential applications
- Can wrap around existing post (modifications may be necessary)
- Lifetime Limited Warranty

† Load-bearing capacity is dependent on distributing the load evenly over bearing surfaces of the shaft. All installation information is of general nature; columns should be installed and secured (fastened) according to standard construction practices and in compliance with applicable local, state and federal building regulations.

Note: 2nd story balconies should not be attached directly to the side of any column.

RECESSED



Our detailed Recessed Columns are complimented by matching capitals and bases. These structural columns are offered in 6" and 8" widths.

DSI is the only aluminum column supplier to receive PCI 4000 A2 & A3 certification from the Powder Coating Institute. All columns are verified AAMA 2604. An optional AAMA 2605 upgrade is available by special order.

RECESSED

Nominal Size	Shipping Weight (lbs.)	Dimensions			
		A Outside	A Inside	B	C
6" x 8'	28	5-1/2"	4-1/8"	8-1/2"	2"
6" x 9'	31	5-1/2"	4-1/8"	8-1/2"	2"
6" x 10'	35	5-1/2"	4-1/8"	8-1/2"	2"
8" x 8'	35	7-1/2"	6-1/8"	10-1/2"	2"
8" x 9'	39	7-1/2"	6-1/8"	10-1/2"	2"
8" x 10'	42	7-1/2"	6-1/8"	10-1/2"	2"

* Column boxes include: 1 pc capital, 1 pc base, and 8 angle brackets



Optional block dividers simplify the rail mounting process or provide a more decorative accent.



Capital
(Low Profile)



Base
(Low Profile)

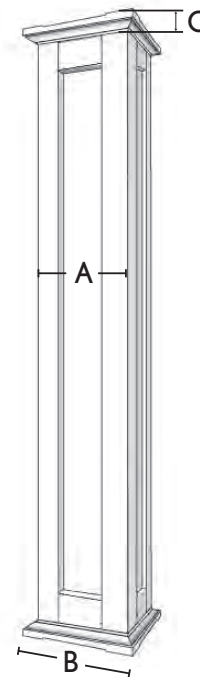

FEATURES



- **Certified PCI 4000 A2 (AAMA 2604) & A3 (AAMA 2605)**
- **Verified AAMA 2604/2605 Compliant**
- Available in 12 colors
- Matching aluminum capitals and bases
- Load bearing† (Visit dsicolumns.com for more information)
- Ideal for commercial and residential applications
- Can wrap around existing post (modifications may be necessary)
- Lifetime Limited Warranty

† Load-bearing capacity is dependent on distributing the load evenly over bearing surfaces of the shaft. All installation information is of general nature; columns should be installed and secured (fastened) according to standard construction practices and in compliance with applicable local, state and federal building regulations. Note: 2nd story balconies should not be attached directly to the side of any column.

SMOOTH



The versatile Smooth Column with matching capitals and bases compliment any home or estate entry.

These structural columns are offered in 6", 8" and 10" widths.

DSI is the only aluminum column supplier to receive PCI 4000 A2 & A3 certification from the Powder Coating Institute. All columns are verified AAMA 2604 compliant. An optional AAMA 2605 upgrade is available by special order.

Nominal Size	Shipping Weight (lbs.)	Dimensions			
		A Outside	A Inside	B	C
6" x 8' * •	27	5-1/2"	4-1/2"	8-1/2"	2"
6" x 9' •	30	5-1/2"	4-1/2"	8-1/2"	2"
6" x 10' •	33	5-1/2"	4-1/2"	8-1/2"	2"
8" x 8' * •	29	7-1/2"	6-1/2"	10-1/2"	2"
8" x 9' •	32	7-1/2"	6-1/2"	10-1/2"	2"
8" x 10' •	35	7-1/2"	6-1/2"	10-1/2"	2"
8" x 12' §	37	7-1/2"	6-1/2"	10-1/2"	2"
10" x 8'	42	9-1/2"	8-1/2"	12-9/16"	2-11/16"
10" x 9'	49	9-1/2"	8-1/2"	12-9/16"	2-11/16"
10" x 10'	53	9-1/2"	8-1/2"	12-9/16"	2-11/16"
10" x 12' §	62	9-1/2"	8-1/2"	12-9/16"	2-11/16"
10" x 20' §	106	9-1/2"	8-1/2"	12-9/16"	2-11/16"

SMOOTH



* Quick Ship Program (Gloss White)

• Column boxes include: 1 pc capital, 1 pc base, and 8 angle brackets

§ Special Order: May require longer lead times.

NOTE: Capitals and Bases are not included with columns unless indicated. Angle Brackets (8 pack) or Tie Down Brackets (2 sets) must be ordered separately from columns unless indicated.



Capital
(Low Profile)

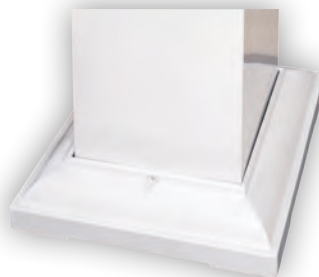

Base
(Low Profile)

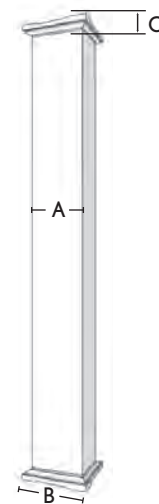

FEATURES



• **Certified PCI 4000 A2 (AAMA 2604) & A3 (AAMA 2605)**



• **Verified AAMA 2604/2605 Compliant**

• Available in 12 colors

• Matching aluminum capitals and bases

• Load bearing†

(Visit dsicolumns.com for more information)

• Ideal for commercial and residential applications

• Can wrap around existing post (modifications may be necessary)

• Lifetime Limited Warranty

† Load-bearing capacity is dependent on distributing the load evenly over bearing surfaces of the shaft. All installation information is of general nature; columns should be installed and secured (fastened) according to standard construction practices and in compliance with applicable local, state and federal building regulations.

Note: 2nd story balconies should not be attached directly to the side of any column.

TIE DOWN BRACKET SYSTEM

- Competitively priced
- Easy to install & inspect
- Mounted to the column shaft for maximum strength
- Works with all columns types
- Packaged as a 2-pack (four brackets required per column)

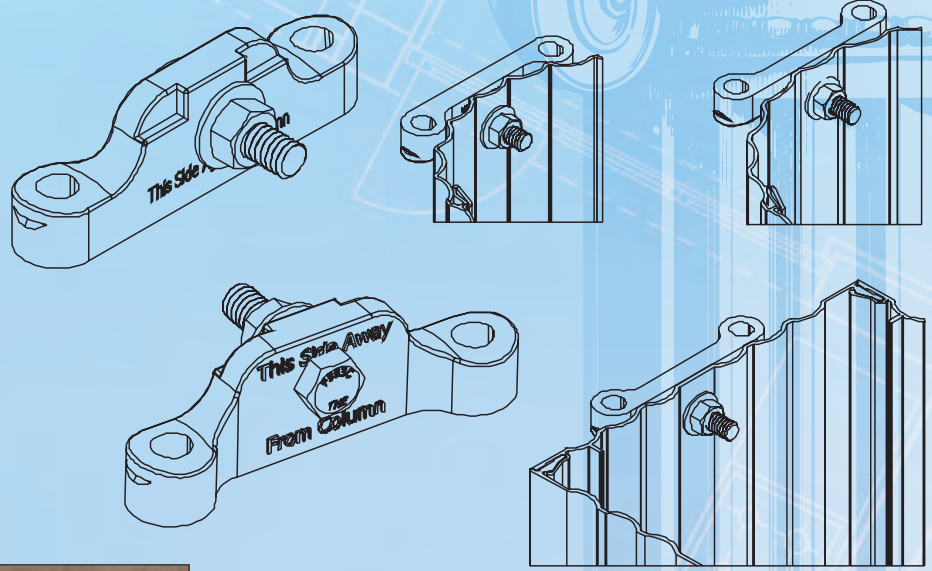

INSTALLATION SHOWN ON ROUND FLUTED ALUMINUM COLUMNS

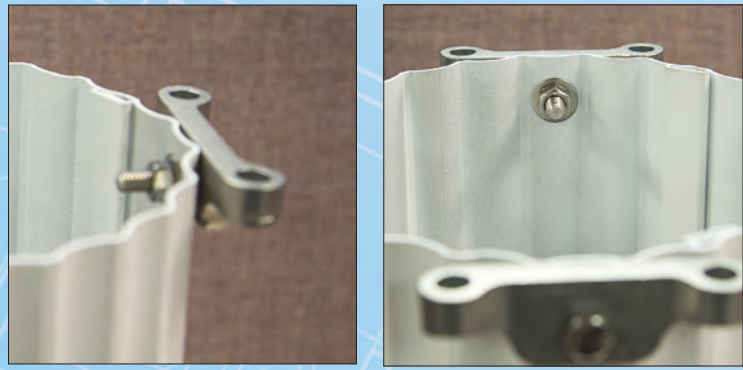

INSTALLATION SHOWN ON SQUARE FLUTED ALUMINUM COLUMNS



ANGLE BRACKET



Packaged as an 8-pack (eight brackets required per column)
 Note: Columns that ship with a capital and base included in the box will also include an 8-pack of Angle Brackets

BULK PACKAGING

MIX 20 COLUMNS PER SKID



SPECIAL ORDER ALUMINUM COLUMN CUTS

DSI Columns are available in the following plan types. Please specify when you order. Round and square column shafts, capitals and bases cut to meet special installation requirements.



Full



3/4 Cut



Engaged Cut



Pilaster Cut



Full



Pilaster Cut



Corner Cut

SPECIAL ORDER ADAPTER KITS FOR VINYL AND ALUMINUM RAILING



Adapter Kit for Round Fluted Column and PolyRail® Vinyl Railing



Adapter Kit for Round Fluted Column and Westbury® Aluminum Railing



STANDARD AAMA 2604 ARCHITECTURAL POWDER COATED COLORS

A variety of standard colors combined with the option of custom colors to compliment your home. From satin colors to textured colors to multi-colors, the possibilities are endless. 12 Standard AAMA 2604 colors available, custom AAMA 2604 colors are available as special order. AAMA 2605 colors are all special order.

Satin Black

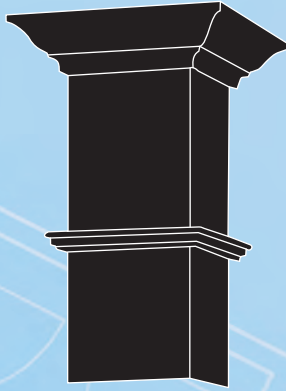

Black Fine
Texture

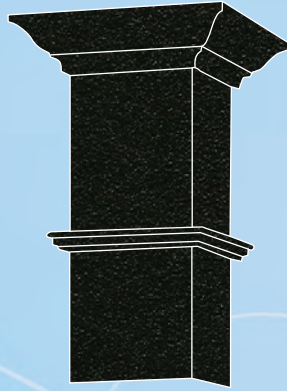

Ninety Bronze

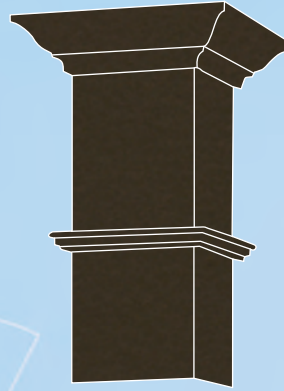

Bronze Fine
Texture



Gloss Beige

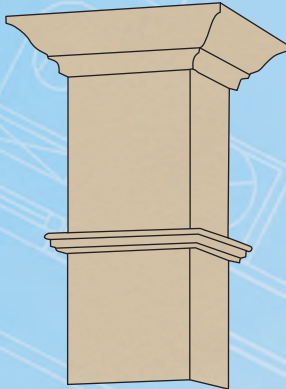

Gloss White

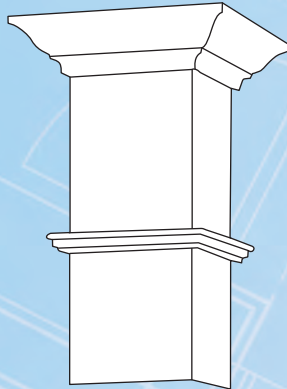

White Fine Texture

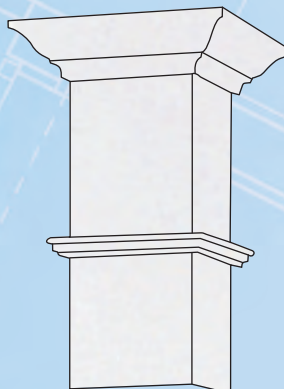

Brown Fine Texture



Speckled
Walnut



Sandy Shore

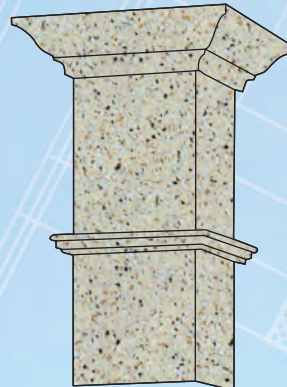

Chocolate

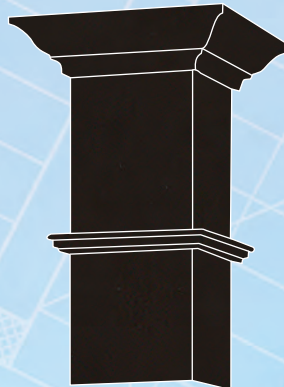

Silver

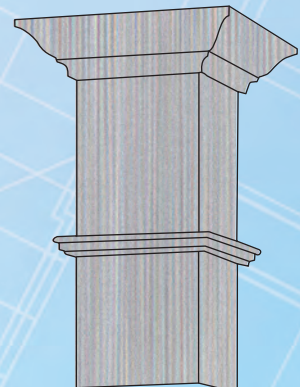

POWDER COATING



1

The raw premium-grade aluminum is inspected to be free of blemishes and is not exposed to the outdoor elements.



2

The product enters a heated acidic cleaning stage to remove extrusion debris and fabrication oils.



3-6

CLEAN: City water rinse
CLEANER: Recycling reverse osmosis water rinse
CLEANEST: Pure reverse osmosis water rinse
SEALER: Dried-in-place aluminum sealer

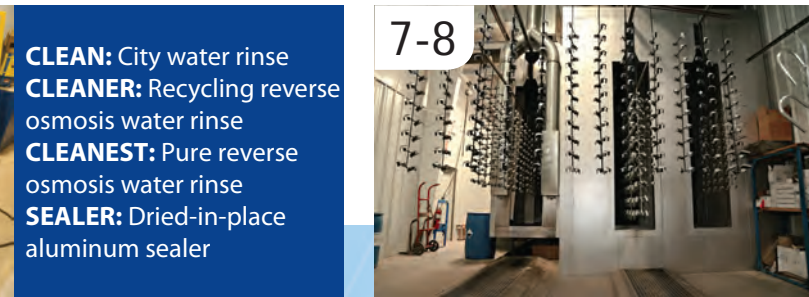

7-8

A 200 MPH air blast removes water drops from the pre-treated aluminum. A convection oven completes the dry-off process.



9

Powder is applied with 18 automated and 2 manual spray guns. Compressed process air is dried to -35°F Dew Point for superior adhesion.

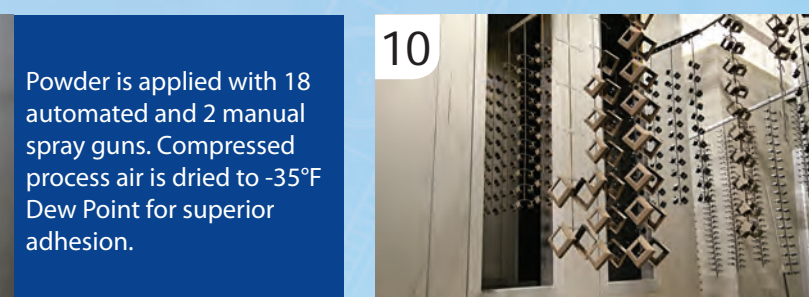

10

The powder coating is then bonded and adhered to the aluminum sub-straight in a 400 degree cure stage.



The powder coating application booth produces zero VOC emissions. Powder is stored and applied in a climate controlled positive pressure environmental room. Ten pre-treat system titration checks twice per shift maintain system parameters and ten QC checks are completed every hour on product coming off the powder-coating line. Parts are not touched by human hands during the pre-treat, dry-off, application and cure process to maintain ultimate cleanliness of powder-coated parts.



DSI is a PCI 4000 certified and verified AAMA 2604 and AAMA 2605 compliant powder coating applicator. The powder coating process is accredited by the American Architectural Manufacturing Association and the Powder Coating Institute. Our powder coating is custom blended from a Super Durable Polyester TGIC (Triglycidyl Isocyanurate) resin-base, using premium pigmentation to meet AAMA 2604 specifications. Our AAMA 2605 is a fluorocarbon polymer resin system.



DSI FAMILY OF PRODUCTS



ScreenRail

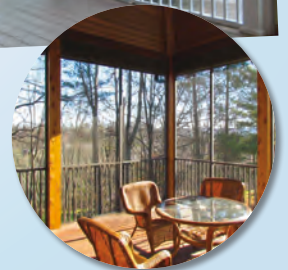

dsicolumns.com

We have tried to make this catalog comprehensive and factual. We reserve the right to discontinue at any time, without notice, colors, materials, equipment and availability. Since some information may have been updated since the time of printing, we are not responsible for typographical or pictorial errors. Materials shown may vary slightly from actual colors. ©Digger Specialties SP 09/17 99720